

# i<sup>3</sup> BX Intelligent Control Station

- 240 x 128 Monochrome LCD Display
- High Resolution Resistive Touch Screen
- MicroSD™ Data storage
- Real Time Clock
- 1 CAN Port, 2 RS-232 / RS-485
- **1 Integral Ethernet Port**
- Addressable function keys
- 256kB RAM (Program), 16MB (Graphical)
- IP65 (NEMA4X)
- 10 - 30 VDC Power Supply
- Free Configuration Software
- Remote I/O Communication
- Optional - Modem (SMS, GSM, GPRS)
- Supports i<sup>3</sup>RMI Webserver Functionality



## Options & Ordering Codes

Standard Options	DI	DO	AI	AO
i3BX12Y/10D03-SEHF	12	6 Relay	4	-
i3BX12Y/13C14-SEHF	12	12	2*	2
i3BX12Y/20B05-SEHF	24	16	2	-
i3BX12Y/10E24-SEHF	12	12	6*	4

\* Universal Analogue Inputs

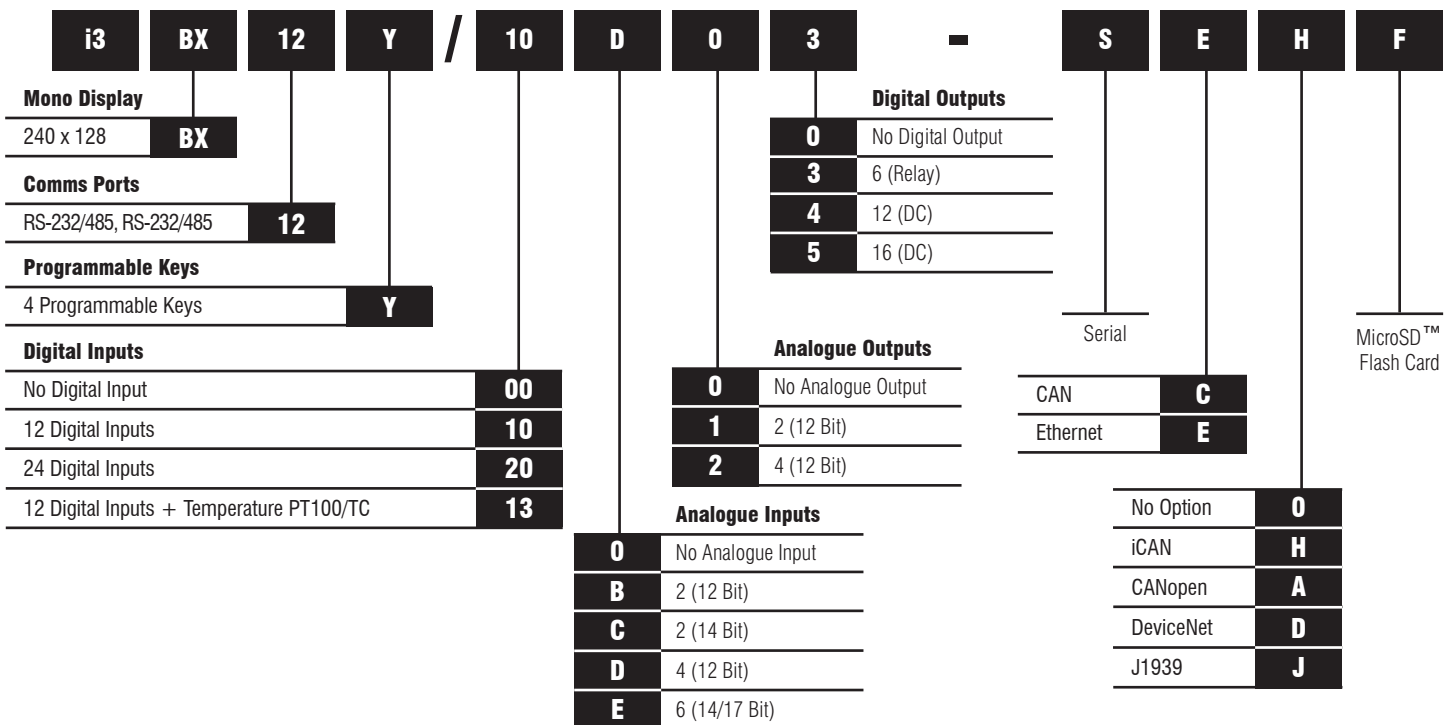

# i<sup>3</sup> BX Intelligent Control Station

## Technical Specifications

General Specifications	
Required Power (Steady State)	84mA @ 24VDC
Required Power (Inrush)	30A for 1ms @ 24VDC
Primary Voltage Range	10-30VDC
Relative Humidity	5 to 95% Non-Condensing
Clock Accuracy	+/-90 Seconds per month at 20°C
Operating Air Temperature	-10°C to +60°C
Storage Temperature	-20°C to +70°C
Weight	0.340kg
Approvals	cUL, UL, CE, FCC

Control & Logic Specifications	
Control Language Support	Advanced Ladder Logic Full IEC 61131-3
Logic Program Size & Logic Scan Rate	256kB Maximum 0.8ms/k
I/O Support	Digital Inputs - 2048
	Digital Outputs - 2048
	Analogue Inputs - 512
	Analogue Outputs - 512
General Purpose Registers	9,999 (words) Retentive 2,048 (bits) Retentive 2,048 (bits) Non-retentive

Display Specifications	
Display Type	Transreflective Touchscreen LCD (outdoor readable)
Resolution	160 x 128
Colour	Monochrome
Screen Memory	16MB
User-Programmable Screens	1023 (maximum 50 objects per screen)
Backlight	LED - 30,000 hour life
Touchscreen Life & Type	1 million touch+; Resistive Type
Screen Update Rate	User configurable within the scan time (perceived as instantaneous in many cases)

Connectivity	
Serial Ports	1 RS-232 or 1 RS-485 on first modular jack (MJ1) 1 RS-232 or 1 RS-485 on second modular jack (MJ2)
USB mini-B	USB 2.0 (480MHz) Programming & Data Access
CAN	Remote I/O, Peer-to-Peer Comms, i3 Configurator
Ethernet	10/100MB (Auto-MDX), Modbus TCP, HTTP, FTP, SMTP, i3 Configurator, Ethernet IP, ASCII TCP
Remote I/O	IOS, Smart I/O, iSmart
Removable Memory	MicroSD™ (support for 32GB max) Application updates, Datalogging, more
Audio	Beeper (system/software controlled)

Input / Output Specifications											
Model	DC In	DC Out	Relays	HS In	HS Out	mA/V In	mA/V RTD/TC	mA/V Out	High Speed Counters		
10D03	12		6	4		4			Number of Counters	4	
10B04	12	12		4	2	2			Maximum Frequency	500kHz each	
20B05	24	16		4	2	2			Accumulator Size	32-bits each	
13C14	12	12		4	2		2	2	Modes Supported		
10E24	12	12		4	2		6*	4*	Totalizer	Quadrature	
There are 4 high-speed inputs of the total DC inputs. There are 2 high-speed outputs of the total DC outputs. Model 10D03, 10B04, 20B05 feature 12-bit Analogue I/O. Model 13C14 features 14/16-bit Analogue I/O. High-speed outputs can be used for PWM and Pulse Train Outputs, currently limited to <10kHz and <65kHz for the 10E24 model. Model 10E14 features a 14/17 bit Analogue I/O.										Pulse Measurement	Frequency Measurement
										2 Position Controlled Outputs 1 ON/OFF Setpoint per Output	

## Dimensions & Panel Cutout

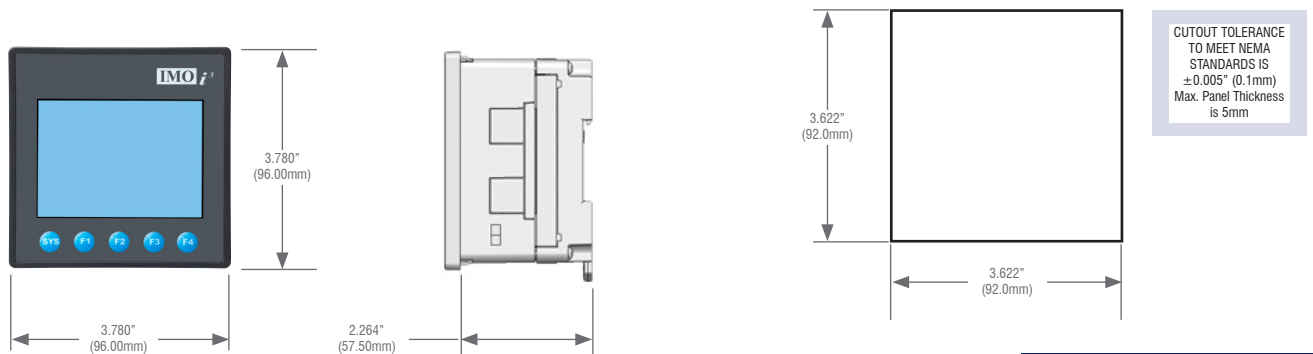

NOTE: Depth including modem = 2.559" (65.0mm)

# i<sup>3</sup> BX Intelligent Control Station

## Ports & Connectors

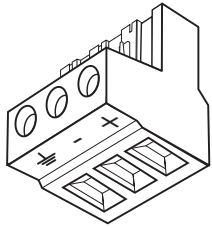

### DC Input / Frame

Torque rating: 4.5-7 Lb-in (0.50-0.78Nm)  
 DC- is internally connected to I/O V-, but is isolated from CAN V-  
 A Class 2 power supply must be used

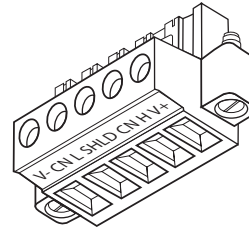

### CAN

Mounting screw torque rating: 4.5 Lb-in (0.50Nm)  
 SHLD and V+ pins are not internally connected to i<sup>3</sup>B

Primary Power Port Pins		
Pin	Signal	Signal Description
1	Ground	Frame Ground
2	DC-	Input Power Supply Ground
3	DC+	Input Power Supply Voltage

Primary Power Port Pins			
Pin	Signal	Description	Direction
1	V-	CAN Ground - Black	-
2	CN L	CAN Data Low - Blue	IN / OUT
3	SHLD	Shield Ground - None	-
4	CN H	CAN Data High - White	IN / OUT
5	V+ (NC)	No Connect - Red	-

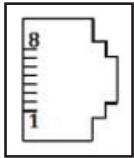

### MJ1 Independent Serial Ports

Two multiplexed serial ports on one modular jack (8posn)

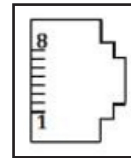

### MJ2 Serial Port

Two multiplexed serial ports on one modular jack (8posn)

PIN	MJ1 PINS	
	Signal	Direction
8	TXD RS-232	OUT
7	RXD RS-232	IN
6	0 V	Ground
5	+5V@60mA	OUT
4	RTS RS-232	OUT
3	CTS RS-232	IN
2	RX- / TX- RS-485	IN / OUT
1	RX+ / TX+ RS-485	IN / OUT

PIN	MJ2 PINS	
	Signal	Direction
8	TXD RS-232	OUT
7	RXD RS-232	IN
6	0 V	Ground
5	+5V@60mA	OUT
4	TX- RS-485	OUT
3	TX+ RS-485	OUT
2	RX- (RX- / TX-*) RS-485	IN or IN/OUT
1	RX+ (RX+ / TX+*) RS-485	IN or IN/OUT

\* In half duplex mode

### DIP Switches

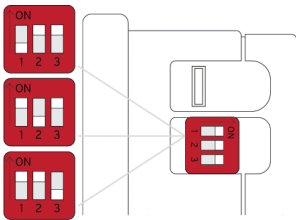

Switch	Name	Function	Default
1	RS-485 Termination (MJ1)	ON = Terminated	OFF
2	RS-485 Termination (MJ2)	ON = Terminated	OFF
3	Factory Use	Always Off	OFF

### Built-in I/O

I/O is mapped into i<sup>3</sup> Register space, in three separate areas – Digital/Analogue I/O, High-Speed Counter I/O, and High-Speed Output I/O. Digital/Analogue I/O location is fixed starting at 1, but the High-Speed Counter and High-Speed Output references may be mapped to any open register location. For more details on using the High-Speed Counter and High-Speed Outputs, see the i<sup>3</sup> BX User's Manual.

Fixed Address	Digital/Analog I/O Function	i <sup>3</sup> BX Model				
		10D03	10B04	20B05	13C14	10E24
%I1	Digital Inputs	1-12	1-12	1-24	1-12	1-12
	Reserved	13-32	13-31	25-31	13-31	13-31
	ESCP Alarm	n/a	32	32	32	32
%Q1	Digital Outputs	1-6	1-12	1-16	1-12	1-12
	Reserved	7-24	13-24	17-24	13-24	13-24
%AI1	Analogue Inputs	1-4	1-2	1-2	1-2	1-4;33-38
	Reserved	5-12	3-12	3-12	3-12	n/a
%AQ1	Reserved	n/a	1-8	1-8	1-8	1-8
	Analogue Outputs	n/a	n/a	n/a	9-10	9-12

Reserved areas maintain backward compatibility with other i<sup>3</sup> Controller models

Default Address*	High Speed Counter Function	i <sup>3</sup> BX Models
%I1601	Status Bits	1-8
%Q1601	Command Bits	1-32
%AI0401	Accumulator 1&2	1-8
%AQ0401	Preload & Match Values	1-12

\*Starting Address locations for %I, %Q, %AI & %AQ may be re-mapped by user

Default Address*	High Speed Output Function	i <sup>3</sup> BX Models
%I1617	Status Bits	1-8
%Q**	Command Bits	1-32
n/a	n/a	n/a
%AQ0421	PWM or Pulse Train Parameters	1-20

\*Starting Address locations for %I & %AQ may be re-mapped by user

\*\*Q1-Q2 are part of the Fixed I/O Map. In High Speed Output mode they can be used to initiate a Stepper/PTO Move

# i<sup>3</sup> BX Intelligent Control Station

## 10D03 I/O Board Specifications

Digital DC Inputs		Digital Relay Outputs	
Inputs per Module	12 including 4 configurable HSC inputs	Outputs per Module	6 Relay
Commons per Module	1	Commons per Module	6
Input Voltage Range	10-30 VDC	Max. Switching Current per Relay	3A @ 250 VAC, Resistive
Absolute Max. Voltage	35 VDC Max	Max. Total Output Current	5A Continuous
Input Impedance	10 kΩ	Max. Switching Voltage	275 VAC, 30 VDC
Input Current	Positive Logic 0.8mA Negative Logic -1.6mA	Max. Switched Power	1250 VAC, 150W
Upper Threshold	0.3mA	Lower Threshold	-2.1mA
Max. Upper Threshold	8 VDC	Contact Isolation to Ground	1000 VAC
Max. Lower Threshold	3 VDC	Max. Voltage Drop at Rated Current	0.5V
OFF to ON Response	1 ms	Expected Life (see below for detail)	No Load: 5,000,000 200,000 at rated load
ON to OFF Response	1 ms	Max. Switching Rate	300 CPM at no load 20 CPM at rated load
HSC Max. Switching Rate	500kHz	Type	Mechanical Contact
		Response Time	One update per ladder scan plus 10ms
Analogue Inputs, Medium Resolution			
Number of Channels	4	Input Ranges	0-10 VDC, 0-20 mA, 4-20 mA
Safe Input Voltage Range	-0.5V to 12V	Input Impedance (clamped @ -0.5VDC to 12VDC)	Current Mode: 100 Ω Voltage Mode: 500 kΩ
Nominal Resolution	12 Bits	%AI Full Scale	32,000
Max. Over Current	35 mA	Conversion Speed	Once per Ladder Scan
Max. Error at 25°C (excluding zero) Adjusting filtering may tighten	4-20 mA 1.00% of FS 0-20 mA 1.00% of FS 0-10 VDC 1.50% of FS	Filtering	160 Hz hash (noise) filter 1-128 scan digital running average filter

J1 (Orange)	Name
I1	IN1
I2	IN2
I3	IN3
I4	IN4
I5	IN5
I6	IN6
I7	IN7
I8	IN8
H1	HSC1 / IN9
0V	Common
A1	Analogue IN1
A2	Analogue IN2
A3	Analogue IN3
A4	Analogue IN4
0V	Common

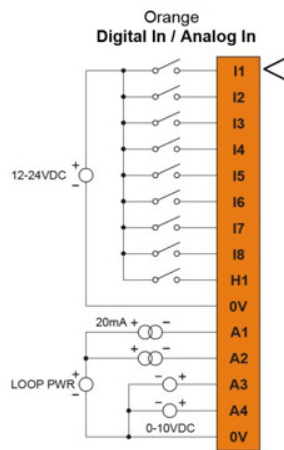

J2 (Black)	Name
C6	Relay 6 COM
R6	Relay 6 NO
C5	Relay 5 COM
R5	Relay 5 NO
C4	Relay 4 COM
R4	Relay 4 NO
C3	Relay 3 COM
R3	Relay 3 NO
C2	Relay 2 COM
R2	Relay 2 NO
C1	Relay 1 COM
R1	Relay 1 NO
H4	HSC4 / IN12
H3	HSC3 / IN11
H2	HSC2 / IN10

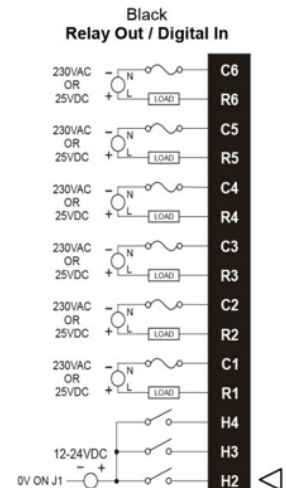

### Jumper Setting Details

Location of I/O jumpers (JP1 & JP2) and wiring connectors (J1 and J2) with back cover removed.

JP1 Digital DC In / HSC	JP2 Analog In (A1 - A4)
Positive Logic	Current (20 mA)
Negative Logic	Voltage (10 V)
Default	A1, A2, A3, A4
001XLE026	Default

**Note:** The Module Setup configuration must match the selected I/O (JP) jumper settings

**Note:** When using JP2 (A1-A4), each channel can be independently configured.

### Relay Life Expectancy

**WARNING:** EXPOSURE TO SOME CHEMICALS MAY DEGRADE THE SEALING PROPERTIES OF MATERIALS USED IN THE Tyco relay PCJ

Cover / case & base: Mitsubishi engineering Plastics Corp. 5010GN6-30 or 5010GN6-30 M8 (PBT)  
Sealing Material: Kishimoto 4616-50K (I part epoxy resin)

It is recommended to periodically inspect the relay for any degradation of properties and replace if degradation is found

# i<sup>3</sup> BX Intelligent Control Station

## Example of Universal Input Wiring Schematic

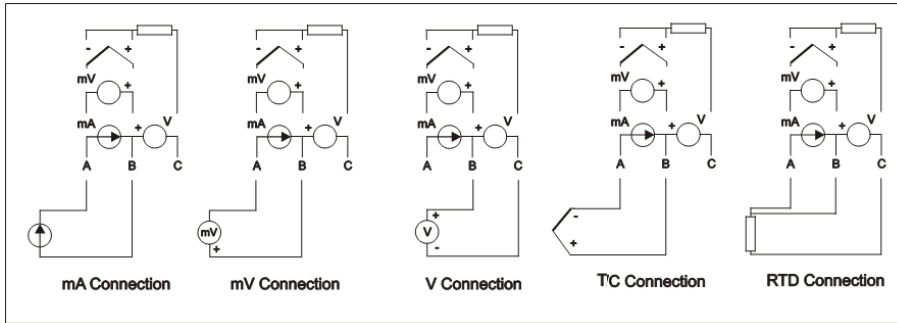

### Configuration

The data registers as follows:-

Digital Inputs	Digital Outputs	Analogue Inputs	Analogue Outputs
%I1-12	%Q1-12	%AI1-4, %AI33-38	%AQ9-12

Note: The first four Analogue inputs are mapped to both %AI1-4 and %AI33-36, analogue input channels 5 & 6 are mapped to %AI37 and %AI38 respectively only.

### Data Values

The analogue inputs return data types as follows:-

Input Mode	Data Format	Comment
0-20mA, 4-20mA	0-32000	
0-10V, 0-60mV	0-32000	
TC, RTD	Temperature in °C or °F to 1 decimal place xxx.y	°C or °F may be selected in the I/O config section. The value is an integer, the user should divide by 10.

### Status Register

Register	Descriptions							
%R1	Bit-wise status register enable – R1.1 – R1.9 enable for registers R2 to R9							
%R2	Firmware version							
%R3	Watchdog count – cleared on power-up.							
%R4	Status bits -				16..4	3	2	1
					Reserved	Normal	Config	Calibration
%R5	Scan rate of the 10E24 board (average) in units of 100µS.							
%R6	Scan rate of the 10E24 board (max) in units of 100µS.							
%R7	Channel Status Channel 2				Channel 1			
	8	7	6	5	4	3	2	1
	Open RTD	Out of Limits	Shorted RTD	Open TC	Open RTD	Out of Limits	Shorted RTD	Open TC
%R8	Channel Status Channel 4				Channel 3			
	8	7	6	5	4	3	2	1
	Open RTD	Out of Limits	Shorted RTD	Open TC	Open RTD	Out of Limits	Shorted RTD	Open TC
%R9	Channel Status Channel 6				Channel 5			
	8	7	6	5	4	3	2	1
	Open RTD	Out of Limits	Shorted RTD	Open TC	Open RTD	Out of Limits	Shorted RTD	Open TC
%R10-14	Reserved							

Note: For the purposes of the example, the block is shown starting at %R1, but it can be set to anywhere in the %R memory map.

# i<sup>3</sup> BX Intelligent Control Station

## Safety

**WARNING:** Battery may explode if mistreated. Do not recharge, disassemble or dispose of in fire.

**WARNING: EXPLOSION HAZARD - BATTERIES MUST ONLY BE CHANGED IN AN AREA KNOWN TO BE NON-HAZARDOUS**

This equipment is suitable for use in Class 1, Division 2, Groups A, B, C and D or Non-hazardous locations only.

**FOR U.S. & CANADA ONLY**

Power input and output (I/O) wiring must be in accordance with Class 1, Division 2 wiring methods of the National Electric Code, NFPA70 for installations in the U.S. or as specified in Section 18-1J2 of the Canadian Electric Code for installations within Canada and in accordance with the authority having jurisdiction.

**WARNING: EXPLOSION HAZARD - Do not disconnect equipment unless power has been switched off or the area is known to be non-hazardous.**

**WARNING: EXPLOSION HAZARD - Substitution of components may impair suitability for Class 1, Division 2.**

Digital outputs shall be supplied from the same source as the i3 Controller.

**WARNING:** Only qualified electrical personnel familiar with the construction and operation of this equipment and the hazards involved should install, adjust, operate, or service this equipment. Read and understand this manual and other applicable manuals in their entirety before proceeding. Failure to observe this precaution could result in severe bodily injury or loss of life.

**WARNING:** To avoid the risk of electric shock or burns, always connects the earth ground before making any other connections.

**WARNING:** To reduce the risk of fire, electrical shock, or physical injury it is strongly recommended to fuse all Power Sources connected to the i3 controller. Be sure to locate fuses as close to the source as possible.

**WARNING:** Replace fuse with the same type and rating to provide protection against risk of fire and shock hazards.

**WARNING:** In the event of repeated failure, do not replace the fuse again as a repeated failure indicates a defective condition that will not clear by replacing the fuse.

Jumpers on connector JP1 and others shall not be removed or replaced while the circuit is live unless the area is known to be free of ignitable concentrations of flammable gases or vapours.

## Common Cause of Analogue Input Tranzorb Failure

If a 4-20mA circuit is initially wired with loop power, but without a load, the analogue Input could see 24VDC. This is higher than the rating of the tranzorb. This can be solved by NOT connecting loop power prior to load connection, or by installing a low-cost PTC in series between the load and analogue input.

